

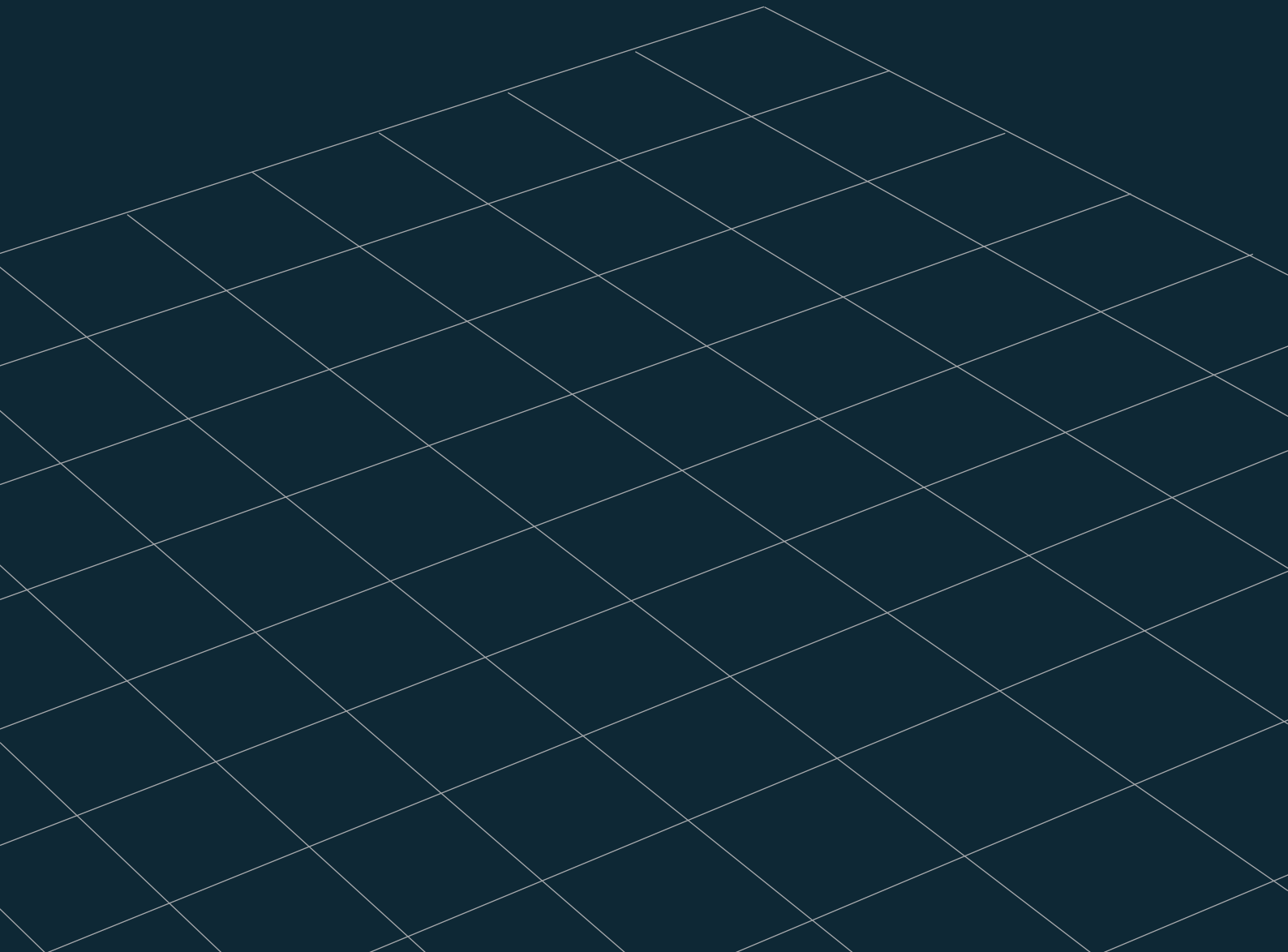

Product Catalogue.



Our Story

Founded in 1994, the United Group caters to the modern construction and building materials industry in India. Since then, we have carved out our niche in the highly specialized business of production and execution of raised flooring solutions for a multitude of businesses.

United group aims to achieve growth of the brand Unitile by innovating and improving raised flooring solutions, to offer our clients the finest product in the market. Our range of flooring panel accessories are manufactured and marketed under the brand name U-FLEX, successfully delivering cooling infrastructure by effectively meeting the modern structure of today's evolving workspaces.



United Group's expanding global presence to accommodate the needs of tomorrow

With the global perspective and workspace knowledge, we successfully operate in India. We execute crucial functions through our division, United Office Systems Pvt. Ltd., which is spread over an area of 100,000 sq. ft. in Gujarat with an annual production capacity of manufacturing 3 million panels of various types. Our Raised Access Floor solutions facilitate the delivery of power, telecoms, data and easy re-configuration of interiors in the work places.



Guaranteed Commitment to quality

Our company offers perfect flooring solutions for offices and data centres and strongly emphasise on delivering the needs of our customers with assured quality and precision. We adhere to the resolute Total Quality Management (TQM) program and our manufacturing facilities are certified under ISO 9001:2008, ISO 14001:2004 and ISO OHSAS 18001:2007 certifications. United Office Systems Pvt. Ltd. is an active member of the Indian Green Building Council (IGBC) and is the only company in Asia to have its products certified by the Singapore Green Building Council (SGBC) thus providing sustainable workspace solutions for our esteemed clients.



Customer Satisfaction is our driving force

We, at Unitile strive for complete customer satisfaction in delivery without a scope of compromised and substandard quality. With our access floor systems, facilities experience ultimate flexibility and modularity with response to technological and organisational changes in cost-effective manner. Over the years, we have maintained good relations with our clients, and they have always come back to us. We view it as an affirmation of our expertise, reliability and collaborative spirit that have awarded us with many long-term working relationships with our valued customers.

Our vision is to be an Indian raised access floor MNC commanding leadership position across geographies we serve by consistently offering safe, innovative and environmental friendly products and solutions through our empowered employees and leading to customer satisfaction.

Keeping in mind the positive, professional and process-driven work culture, we strive to develop the technical proficiency in our business by building cost competitive, value engineered innovative products and services delivered proactively and consistently to meet your exclusive needs.

Why Unitle?

With over two decades of experience, Unitle is India's market leader of Raised Access Floor systems. Unitle provides successful and efficacious flooring solutions to the modernized world by comprehensively understanding the workplace environment. With exceptional product quality and an unsurpassed technical support services, Unitle is successfully redefining the structure of today's ever-evolving workspaces.



23 years of excellence and expertise in manufacturing & execution of Raised Access Floor Systems.



An ISO 9001:2008, ISO 14001:2004 & OHSAS 18001:2007 certified enterprise.



Green products, having valued certifications from Singapore Green Building Council (SGBC) & Indian Green Building Council (IGBC).



Excellence guaranteed with all products being third party tested at TÜV SÜD PSB, Singapore & Bureau Veritas, France.



Annual production capacity of 3 million panels as a mark of versatility and variety.



Recognized for transforming over 40 million sq. ft Data Centers and Office Spaces of 14,000+ globally satisfied customers!



More than 99% positive customer feedbacks, a standing testimony to success and uncompromised commitment.



The only raised access floor company in India with 250+ members on board, skilled at delivering satisfaction, right from execution to after-sales services.

CONSTRUCT YOUR
FUTURE PROFESSIONALLY

Manufacturing & Quality Assurance

For over 23 years, the entities that comprise United Office Systems Pvt. Ltd. have been industry pacesetters in the design, development and manufacturing of the most sophisticated raised access flooring systems.

With over a 100,000 sq. ft. of covered area, the factory has been designed utilizing the world- leading manufacturing processes and technology.

Delivering products for various raised floor applications, the firm is renowned in the industry for a manufacturing reputation centered on innovation and reliability. We have earned that reputation by rapidly assessing the critical needs of a project, and then executing a timely production plan in order to successfully meet the project timelines.

Broadly defined, our capabilities include design, quick turn-around times, manufacturing, assembly, testing, inspection and more.

Careful screening of suppliers, inspection of incoming materials, state-of-the- art production equipment and conscientious employees all contribute towards firm's quality advantage.

We have developed a world class technically advanced in-house testing facility to ensure that the manufactured products are meeting the desired quality standards and for our customers to witness the live testing process. Our products are further third party tested at the facilities of TUV PSB – Singapore, which validates our products, to conform to the International Standards like Master Specs & CISCA (USA), BSEN (Europe) and MOBPF2PS(UK).

Our goal is to build high quality long-term supplier relationships with our customers by delivering the highest value and best service.



Spreading over a vast area of 1,00,000 sq. ft., the manufacturing & innovation centre utilizes the world - leading processes and technologies.

Floors for the Environment

The Unitile advanced technology platform has a host of benefits for your business in its growing responsibility to both the staff as well as the environment. This system brings you cost-effective solutions that can help your business achieve the 'green' status with optimum air, sound and light to promote a healthy and productive work environment. Further, its elegance is sure to add aesthetic appeal to your building, giving your business an upper hand with creating the right image and attracting prospective clients and staff.

Materials and resources



- ◆ Unitile Raised access floor system is specifically created from recycled components and materials that meet Singapore Green Building Council Standards (SGBC) for safety and low emission.
- ◆ The panel infill is made up of recyclable contents such as non combustible cement.
- ◆ Contributes to LEED points for recycled and / or recyclable materials and energy efficiency.

Drastically reduces the dead load on the base building



- ◆ The dead load of 3" of raised flooring system is only 35 to 42 Kg/ Sq. m. on the mother slab as against that of 3" of IPS (concrete) is 150 - 170 Kg / Sq. m.
- ◆ Reconfiguration in spaces with conventional flooring involves breaking the concrete structure to access wires and cables concealed in the floor. Due to this reason, repeated reconfiguration results in the weakening of the base building.

Lifespan exceeding 25 years



- ◆ Owning a raised flooring system is a permanent asset for the tenant. On the completion of the lease period in a facility, the complete system can be dismantled and relocated to the customer's new facility.
- ◆ With water leveled floors and fixed finished floor heights, all the modular partitions can be reused in the new facility.
- ◆ The same is valid for cable trays functioning beneath the floor, which would have been impossible in case of the conventional flooring where cables are embedded in concrete.

A green status update for your business!



Need your business to reach Green Building Status? Our raised access floors provide numerous ways of attaining LEED points for your business! Our floors enable you to enhance the green building performance of your facility, thanks to their supportive functioning in the demanding areas of materials and resources.



We have the honor of being the only company in India to achieve the green certification from **Singapore Green Building Council (SGBC)** with a **two-tick remark**.

Why Raised Access Floor System?

Raised access floor systems are designed keeping in mind the constantly evolving needs of the new age workspace. They can efficiently respond to organizational and technological changes quickly and easily, attenuate noise, improve personal comfort control and enhance the aesthetics of the workspace. Also, a raised access floor system is a long term cost-effective investment, providing a tremendous amount of flexibility and capacity in minimal time.

A perfect platform for business, this system reduces life cycle costs and is designed to meet the most demanding needs of new or refurbished buildings, offering you a flexible and high performance solution.

What is a Raised Access Floor System?

Raised access floors is a platform built several inches above the structural floor, creating a cavity/void between the existing floor/slab and the top surface of raised access floor system.

Purpose of Cavity:

- ◆ Passing Electrical/Data/Voice/Power cables
- ◆ Plumbing pipes
- ◆ Air conditioning piping and cable in equipment room

The system is completely modular; any panel can be uncovered to access the wires beneath, enabling changes to be made easily without the need for skilled manpower or specialized equipment in minimal downtime.

Why use a Raised Access Floor System?



The system responds to organizational & technological changes quickly and easily.



Provides a tremendous amount of flexibility & capacity in minimal time.



An access floor system reduces the facilities life cycle costs.



Designed to meet the most demanding needs of new or refurbished buildings.



A long term cost-effective investment.



Flexible and a high performance solution.

With the integration of raised access floor systems, you can transform any facility into a strategic asset - one you can rely on to deliver measurable benefits.

Applications of Raised Access Floor System

Open Offices



Data Centers



Control Rooms

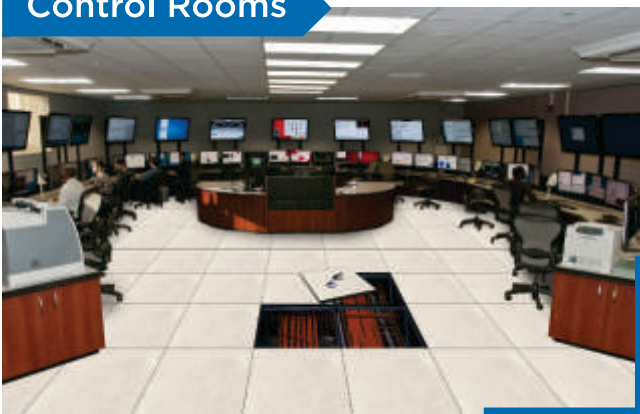

External Spaces



Education



Casinos



Other Applications:



Research Labs | Training Rooms | Switch Rooms | Server / Hub Rooms |
Communication Rooms | Hotels | Hospitals | Libraries | Auditoriums | Conveyor Belts
Mezzanines and many more...

PRODUCTS - Steel Cementitious Panel

UNIFOLD PANEL (UFP)

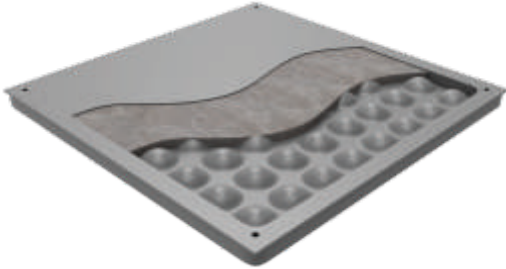
Now footsteps won't disturb your work!



-  Non-combustible
-  Coated with Electrostatic Epoxy paint

- Dimensions:** 600mm x 600mm
- Panel Thickness:** 30 mm | 35 mm
- Top:** Flat steel
- Bottom:** Flat steel uniquely designed to form hemispherical reinforcing pockets
- Core:** Lightweight proprietary cementitious mixture

The uniqueness of this panel design is it engineered folded edges along the perimeter of the panel, which eliminates damage to the panel edges. Its wider beam width not only enhances the load carrying performance of the system but also provides a squeak free floor.

DESIGN FEATURES

- ◆ Unique folded flange design increases edge strength
- ◆ Wider and stronger beam increases footprint area on the pedestal head and boost the panel's structural performance and stability.
- ◆ Engineered countersunk feature enhances panel support & eliminates overlapping of panels.

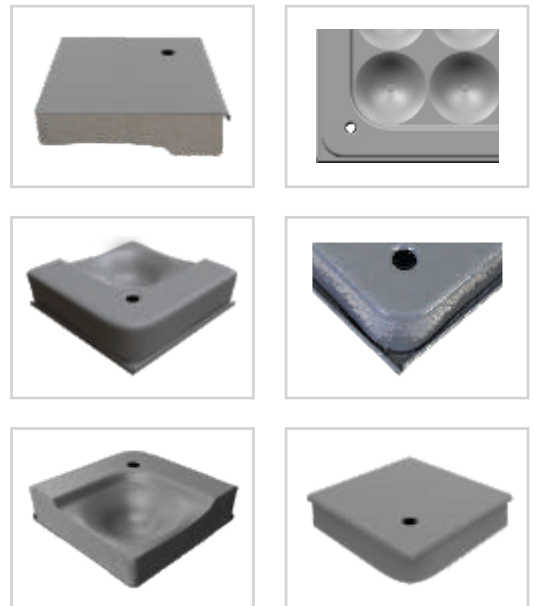

BENEFITS

- ◆ Guaranteed no squeaking sound.
- ◆ Reduces risk of material damage & ensures personal safety to on-site workers.
- ◆ Perfectly aligned water leveled floor.
- ◆ Reduces manpower and improves speed of construction for the allied agencies as few panels can be gravity laid.
- ◆ Eliminates reworking and straightening of the edges post installation due to the folded flange panel technology.

System Selection Guide

Grade	UFP 1650	UFP 2250
Concentrated Load kgs (lbf)	360 (800)	450 (1000)
Ultimate concentrated Load kgs (lbf)	1080 (2400)	1350 (3000)
Uniform Distributed Load kgs / sq mt (lbf / sq ft)	1650 (340)	2250 (464)
Rolling Load* kgs (lbf)	180 (400)	225 (500)

* Contact us for detailed specifications of the product design.

Understructure Support System: Corner Lock



Each floor panel is mechanically secured to the pedestal head at all four corners ensuring maximum rigidity and lateral stability. Access to the sub-floor is very simply achieved by releasing the fasteners and lifting the panel.

Finished Floor Height:

Minimum: 65 mm
Maximum: 2000 mm

PRODUCTS - Steel Cementitious Panel

LOW FLANGE WIDTH (LFW)

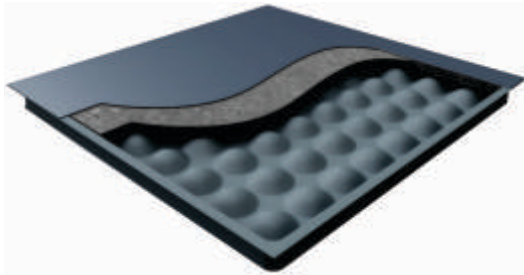

-  Non-combustible
-  Coated with Electrostatic Epoxy paint

Dimensions: 600mm x 600mm | 600mm x 800mm
Panel Thickness: 30 mm | 35 mm
Top: Flat steel
Bottom: Flat steel uniquely designed to form hemispherical reinforcing pockets
Core: Lightweight proprietary cementitious mixture

The cantilever edges of the panel are reduced and this unique product design enhances the technical performance of the system, reduces the risk of damage at site and aims to provide tremendous advantages to the user.

DESIGN FEATURES

- ◆ Increased footprint area improves load carrying performance.
- ◆ Reduced & low cantilever edge provides higher strength to unsupported edge and reduces risk of damage.
- ◆ Wider beam increases overall stability of the system.
- ◆ Box Stringer design and corner edge support improves lateral rigidity of grid.
- ◆ Perfectly leveled floor due to panels being snug fit and bedding free design.

System Selection Guide

Grade	USF 800	USF 1000	USF 1250	USF 1500	USF 2000	USF 2500
Concentrated Load kgs (lbf)	363 (800)	454 (1000)	567 (1250)	680 (1500)	907 (2000)	1134 (2500)
Ultimate concentrated Load kgs (lbf)	907 (2000)	1134 (2500)	1418 (3125)	1701 (3750)	1814 (4000)	2268 (5000)
Uniform Distributed Load kgs / sq mt (lbf / sq ft)	1650 (338)	2025 (415)	2450 (502)	3100 (636)	3600 (738)	4000 (820)
Rolling Load* kgs (lbf)	180 (397)	225 (496)	281 (619)	315 (694)	425 (937)	525 (1157)

* Contact us for detailed specifications of the product design.

Understructure Support System: Corner Lock

Corner Lock System



Each floor panel is mechanically secured to the pedestal head at all four corners ensuring maximum rigidity and lateral stability. Access to the sub-floor is very simply achieved by releasing the fasteners and lifting the panel.

Finished Floor Height:

Minimum: 65 mm
Maximum: 2000 mm

Understructure Support System: ESRG

Edge Support Rigid Grid System



Edge support under-structure provides maximum floor stability. It reduces all lateral movements and also ensures integrity of the floor on removal of panels for access to services in the sub-floor. Stringers are mechanically fastened to the pedestal head and panels are then placed on the grid formed. This system is ideal for high finished floor heights.

Finished Floor Height:



Minimum: 65 mm
Maximum: 2000 mm

PRODUCTS - Steel Cementitious Panel

UNILOCK PANEL (ULP)

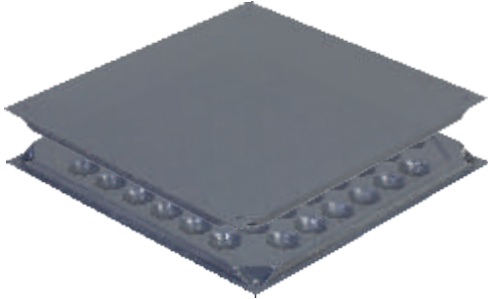
Now you can imagine a lock without a key!



-  Non-combustible
-  Coated with Electrostatic Epoxy paint

Dimensions: 600mm x 600mm

Panel Thickness: 30 mm

Top: Flat steel

Bottom: Flat steel uniquely designed to form hemispherical reinforcing pockets

Core: Lightweight proprietary cementitious mixture

The Unilock design enables easy access to the cavity and enhances the flexibility for a user to have a combination of fastened & unfastened panels within the same installation.

DESIGN FEATURES

- ◆ Integral shaped panel corners enables positive lateral retention and positioning of the panel.
- ◆ Easy access to cavity and enhances the flexibility for a user to have a combination of fastened and unfastened panels within the same installation.
- ◆ Specially designed screws with unthreaded shank for achieving the self capturing.
- ◆ Panels can be stacked on top of each other without removing fasteners.
- ◆ Unique Panel corner design provides a positive location and lateral engagement of the panel to the understructure support system without the use of screws.
- ◆ Double locking system can be achieved by fastening the panels to pedestal heads by the use of a machine screws which are specially designed to be self capturing within the body of the panel.

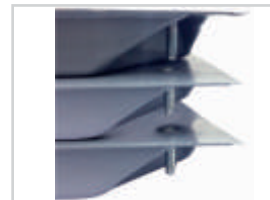
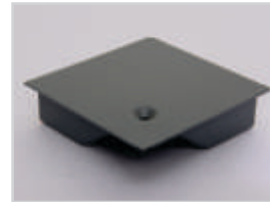

System Selection Guide

Grade	ULP 800	ULP 1000
Concentrated Load kgs (lbf)	363 (800)	454 (1000)
Ultimate concentrated Load kgs (lbf)	907 (2000)	1134 (2500)
Uniform Distributed Load kgs / sq mt (lbf / sq ft)	1650 (340)	2250 (464)
Rolling Load* kgs (lbf)	180 (400)	225 (500)

* Contact us for detailed specifications of the product design.

Understructure Support System: Corner Lock

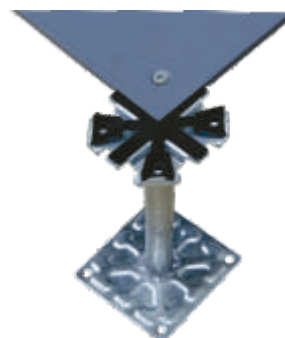

Each floor panel is mechanically secured to the pedestal head at all four corners ensuring maximum rigidity and lateral stability. Access to the sub-floor is very simply achieved by releasing the fasteners and lifting the panel.

Finished Floor Height:

Minimum: 65 mm
Maximum: 1200 mm

PRODUCTS - Steel Cementitious Panel

ULTRA THIN PANEL (ULT)

Thin & light, yet rock solid!

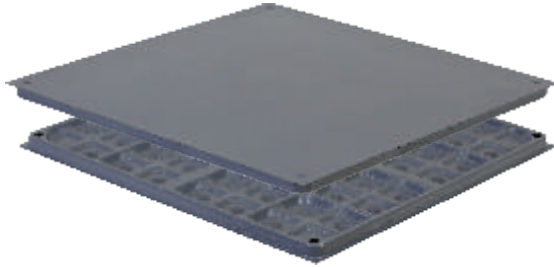

-  Non-combustible
-  Coated with Electrostatic Epoxy paint

- Dimensions:** 600mm x 600mm
- Panel Thickness:** 22 mm
- Top:** Flat steel
- Bottom:** Flat steel uniquely designed to form square pockets with special reinforced beams
- Core:** Lightweight proprietary cementitious mixture

The unique engineering & design ensures structural integrity of the panel and its understructure system for a general office application, tested as per international standards.

DESIGN FEATURES

- ◆ **Unique thin design:**
 - Eliminates height constraints.
 - Provides additional plenum in existing finished floor heights. Enables routing and access of the PVD services with ease in low finish floor height.
- ◆ **Lightweight construction:**
 - Drastically reduces the dead load on the mother slab (80% lighter as compared to 3 inches of IPS).
 - Enables handling and opening of the panels with ease.
- ◆ **Unique low flange width design:**
 - Prevents edge damage
 - Ensures safety of workers
 - Increases the product life
- ◆ **Enhanced Technical performance:**

Due to the engineered square pockets with special reinforced beam design.

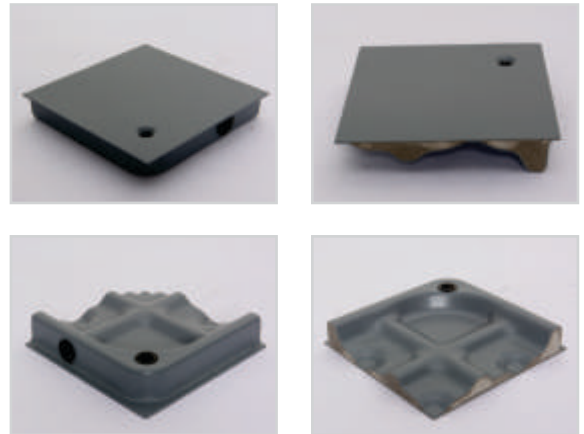

System Selection Guide

Grade BSEN 12825	Ultra Thin
Point Load kgs (lbf)	412 (912)
Ultimate Point Load kgs (lbf)	825 (1800)
Uniform Distributed Load kgs/sq mt (lbf/sq ft)	1237 (254)
Ultimate UDL kgs (lbf)	2475 (5500)
Rolling Load* kgs (lbf)	180 (400)
Pedestal Axial Load kgs (lbf)	1648 (16.16)

* Contact us for detailed specifications of the product design.

Understructure Support System: Corner Lock

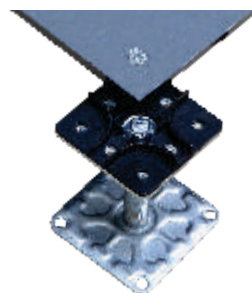

Each floor panel is mechanically secured to the pedestal head at all four corners ensuring maximum rigidity and lateral stability. Access to the sub-floor is very simply achieved by releasing the fasteners and lifting the panel.

Finished Floor Height:

Minimum: 65 mm
Maximum: 2000 mm

PRODUCTS - Chipboard Panel

CHIPBOARD ENCAPSULATED PANEL (UWC)

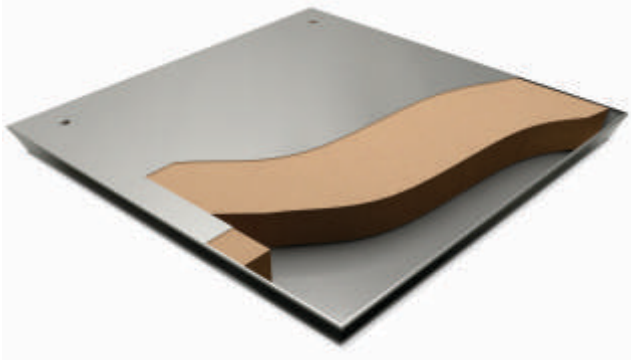

Dimensions: 600mm x 600mm
Panel Thickness: 27 mm | 31 mm
Top: Galvanized Iron Sheet
Bottom: Galvanized Iron Sheet
Core: High density E1 grade chipboard core

This double folded lock constructs into a panel that has a unique in-built stringer at the underside of each panel edge.

This unique engineering exhibits fine dimensional tolerances for modular control, accurate alignment of grids & inter-changeability of panels that complies with the Euro Class requirement of EN 12825.

Unitile's Wood core product range are made from chipboard particles which are extracted from well managed forests, controlled sources or recycled wood of fibre.

This post consumer recycled chipboard particles not only prevent the cutting of trees required for manufacturing of such wood related products but also prevents them from going to near capacity landfill sites.

DESIGN FEATURES

- ◆ High strength to weight performance.
- ◆ Unique inbuilt stringer design.
- ◆ Recyclable & Environment friendly system.
- ◆ Excellent fire resistance properties tested as per Class O & Class 1.
- ◆ Good Acoustical Properties.
- ◆ Enhanced lateral stability, flexural stiffness & mechanical resistance.
- ◆ Precision in floor levels and positive alignment with the understructure system.
- ◆ Equipotential reinforcement for electrical continuity.

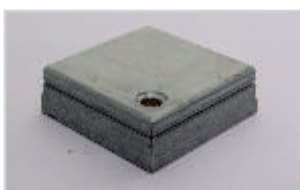
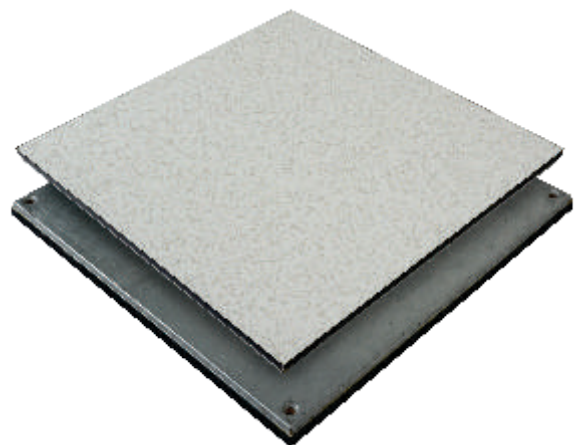

PRODUCTS - Chipboard Panel

System Selection Guide

Structural Performance as per BSEN 12825		27 mm	31 mm
Classification	Deflection	Concentrated Load kgs (KN)	Concentrated Load kgs (KN)
Class A	2.5 mm	544 / 5.34	578 / 5.67
Class B	3.0 mm	608 / 5.96	600 / 5.88
Class C	4.0 mm	726 / 7.12	728 / 7.14
Ultimate Concentrated Load		1678 Kgs / 16.45 KN	1728 Kgs / 16.94 KN
Uniformly Distributed Load Kgs / sq mtr.		1400 Kgs / sq mtr.	1600 Kgs / sq mtr.
Pedestal Axial Load Test		22 KN (2245 kgs) Axial Load per pedestal	22 KN (2245 kgs) Axial Load per pedestal

* Contact us for detailed specifications of the product design.

Understructure Support System: Corner Lock



Corner Lock System

This system is suitable for the widest variety of office applications. Each floor panel is mechanically secured to the pedestal head at all four corners ensuring maximum rigidity and lateral stability. Access to the sub-floor is simply achieved by releasing the fasteners and lifting the panel.

Finished Floor Height:

Minimum: 150 mm
Maximum: 2000 mm

Understructure Support System: Gravity Lay System



Gravity Lay System

Identical performance features as the Unitile Corner Lock System, used for finished floor height as low as 65mm. With this systems the range of vertical adjustment is therefore limited.

Finished Floor Height:

Minimum: 150 mm
Maximum: 2000 mm

PRODUCTS - Chipboard Panel

CHIPBOARD NON-ENCAPSULATED PANEL (UCB)

Dimensions: 600mm x 600mm
600mm x 800mm
Panel Thickness: 35 mm | 38 mm
Top: Galvanized Iron Sheet
Bottom: Galvanized Iron Sheet
Core: High density E1 grade chipboard core

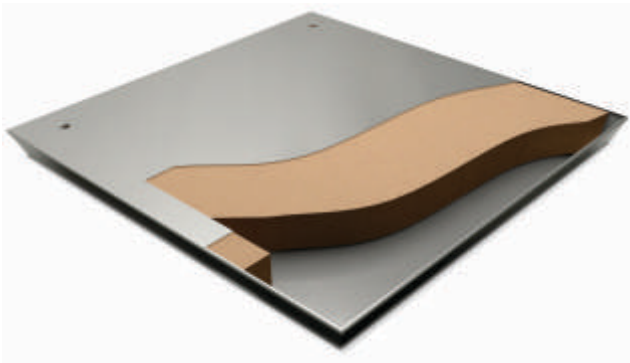

Unifite Chip Board Access Floor consists of engineered 600 mm square modular panels constructed around a high density E1 grade chipboard core. The system fully complies with the Euro Class requirement of EN 12825.

The base and the top surface of the core is factory bonded using an appropriate combination of surface finishes such as Aluminum, Galvanized sheet steel, High Pressure Laminate etc. The surface coverings are trimmed to ensure fine dimensional control, accurate alignment of grids and inter-changeability of panels. A full depth ABS edge band provides total encapsulation of the chipboard core and also protects the edge of the surface covering to prevent ingress of moisture. Electrical continuity is maintained through the top and bottom surface of the panel on to the pedestal head through conductive gasket. This ensures positive positioning and location of the floor panel on to the understructure system.

DESIGN FEATURES

- ◆ High strength to weight performance.
- ◆ Unique inbuilt stringer design.
- ◆ Recyclable & Environment friendly system.
- ◆ Excellent fire resistance properties tested as per Class O & Class 1.
- ◆ Good Acoustical Properties.
- ◆ Enhanced lateral stability, flexural stiffness & mechanical resistance.
- ◆ Precision in floor levels and positive alignment with the understructure system.
- ◆ Equipotential reinforcement for electrical continuity.

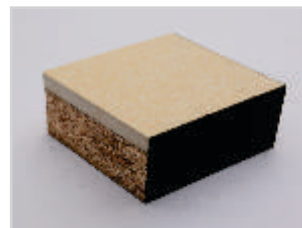
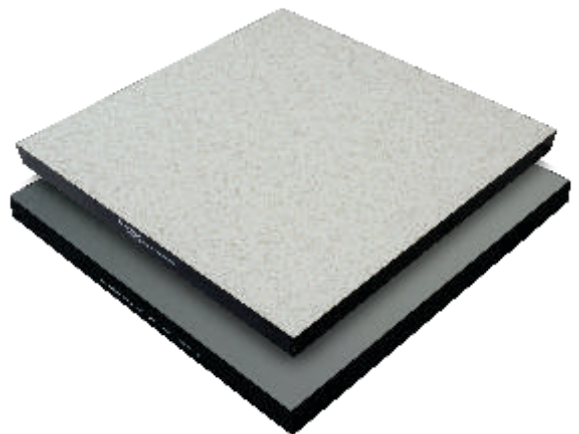

PRODUCTS - Chipboard Panel

UNITILE CHIPBOARD (LA)

Top Panel

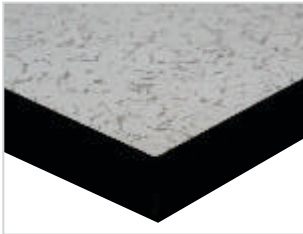

HPL / PVC (L)

Bottom Panel

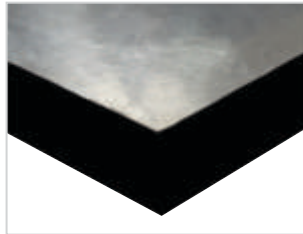

Aluminium Foil (A)

UNITILE CHIPBOARD (LG)

Top Panel

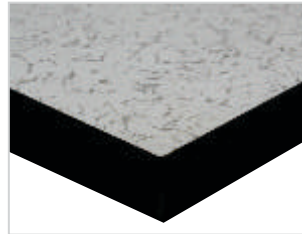

HPL / PVC (L)

Bottom Panel

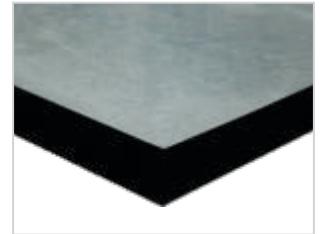

Galvanized Steel (G)

System Selection Guide

Structural Performance as per BSEN 12825		35 mm	38 mm
Classification	Deflection	Concentrated Load kgs (KN)	Concentrated Load kgs (KN)
Class A	2.5 mm	530 / 5.19	660 / 6.47
Class B	3.0 mm	600 / 5.88	690 / 6.76
Class C	4.0 mm	740 / 7.25	840 / 8.23
Ultimate Concentrated Load		1600 Kgs / 15.68 KN	1650 Kgs / 16.17 KN
Uniformly Distributed Load / Sq mtr.		2300 Kgs / Sq. mtr.	2350 Kgs / Sq. mtr.
Pedestal Axial Load Test		22 KN (2245 kgs) Axial Load per pedestal	22 KN (2245 kgs) Axial Load per pedestal

* Contact us for detailed specifications of the product design.

Understructure Support System: ESGR

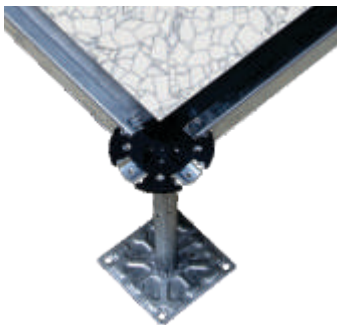

Edge Support Rigid Grid System

Edge support under-structure provides maximum floor stability. It reduces all lateral movements and also ensures integrity of the floor on removal of panels for access to services in the sub-floor. Stringers are mechanically fastened to the pedestal head and panels are then placed on the grid formed. This system is ideal for high finished floor heights.

Finished Floor Height:

Minimum: 150 mm
Maximum: 2000 mm

UNITILE CALCIUM SULPHATE (UCS)

Dimensions: 600mm x 600mm

Panel Thickness: 30 mm | 34 mm

Top: Galvanized Iron Sheet / Anti Static High Pressure Laminate Static Dissipative / Conductive Vinyl

Bottom: Galvanized Iron Sheet

Core: Natural gypsum of high density over 1500 kgs /mtr³

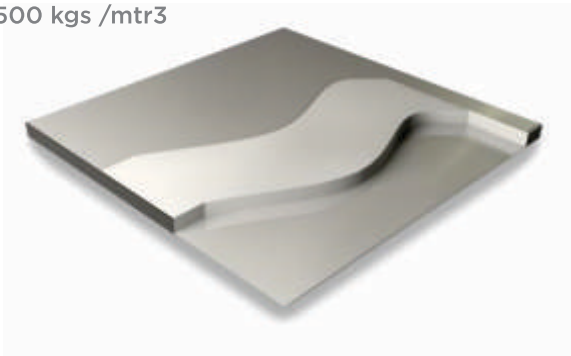

Unitile Calcium Sulphate access flooring system is manufactured from 1500 Kg fibre reinforced Calcium Sulphate which forms the core of the panel. Non-combustible high quality alpha-hemihydrate single pressed gypsum and non-toxic unbleached cellulose fibers are used as reinforcing material.

The base & top surface of the core is factory bonded using an appropriate combination of surface finishes such as Aluminum, Galvanized sheet steel, High Pressure Laminate etc. The edges of the panel are protected with a PVC edge band. The system offer an excellent acoustical sound deadening value.

DESIGN FEATURES

◆ Acoustic Characteristics:

The material structure, design features, and high precision production of the access floor panels provide excellent acoustic values. The great walking properties offer a high degree of comfort and create the perfect working environment.

◆ Electrostatic Characteristics:

Electrostatic charges are dissipated, regardless of panel material, by the inherent design features. The ohmic resistance defined in this way allows grounding compliance in accordance with VDE 0100 using suitable floor coverings.

◆ Ecology:

Due to the environmentally-friendly production process, and the use of ecologically safe materials, 90 to 97% of the calcium sulphate panels can be recycled at the end of their life - a very important ecological consideration today.

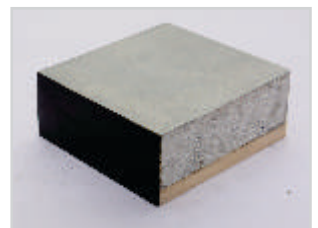
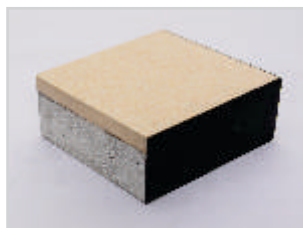
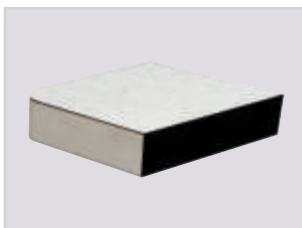
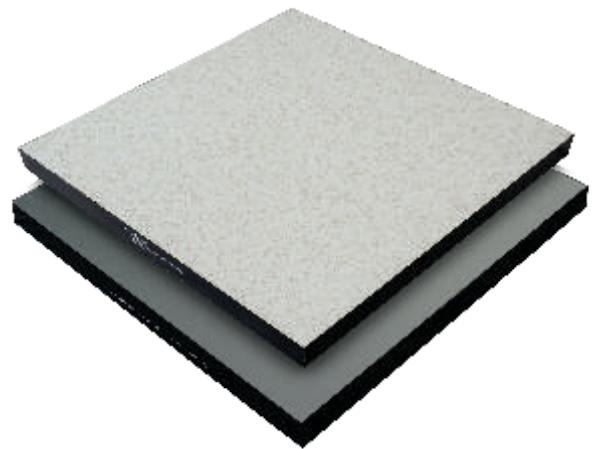

PRODUCTS - Calcium Sulphate Panel

UNITILE CALCIUM SULPHATE (LA)

Top Panel

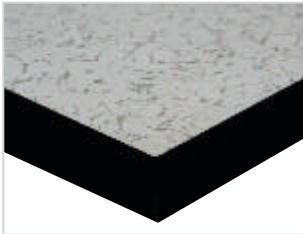

HPL / PVC (L)

Bottom Panel

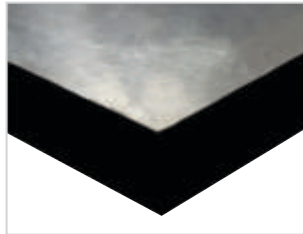

Aluminium Foil (A)

UNITILE CALCIUM SULPHATE (LG)

Top Panel

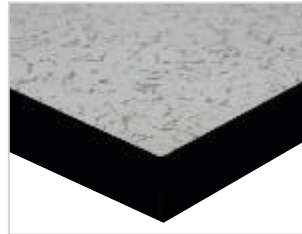

HPL / PVC (L)

Bottom Panel

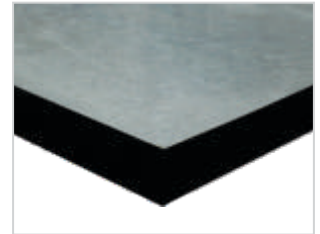

Galvanized Steel (G)

System Selection Guide

Structural Performance as per BSEN 12825		30 mm	34 mm
Classification	Deflection	Concentrated Load kgs (KN)	Concentrated Load kgs (KN)
Class A	2.5 mm	700 / 6.86	740 / 7.25
Class B	3.0 mm	800 / 7.84	830 / 8.13
Class C	4.0 mm	900 / 8.82	970 / 9.50
Ultimate Concentrated Load		1200 / 11.76	1650 / 16.17
Uniformly Distributed Load Kgs / Sq. mtr.		2900 Kgs / Sq. mtr.	3000 Kgs / Sq. mtr.
Pedestal Axial Load Test		22 KN (2245 kgs) Axial Load per pedestal	22 KN (2245 kgs) Axial Load per pedestal

* Contact us for detailed specifications of the product design.

Understructure Support System: Gravity Lay



Substructure in
Galvanized Steel

Model: Free Standing
Adjustment mm: +/-25

Finished Floor Height:

Minimum: 150 mm
Maximum: 2000 mm

Understructure Support System: ESRG

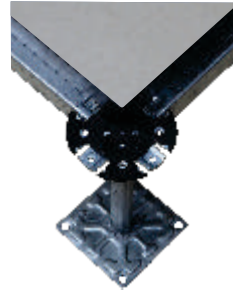

Substructure in Galvanized
Steel with support &
stringers for substructure
height of over 300mm

Model: ESRG
Adjustment mm: +/-25

Finished Floor Height:

Minimum: 150 mm
Maximum: 2000 mm

Top Performance Finishes

Available Finishes

High Pressure Laminate



HPL - 8194

PVC / Vinyl Conductive



PJD - 9022

Other Finishes

Vitrified

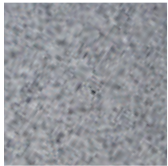

Ceramic



Carpets

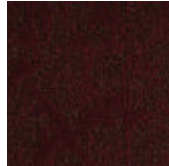

**The following non-stock bonded finishes are available to order on longer lead times.*

Please note: Every effort has been made to give a true representation of the finishes shown, however Unitile cannot guarantee 100% accuracy due to the constraints of the printing process.

PRODUCT COMPATIBILITY CHART

PANEL TYPE	Carpet	Bare	HPL	PVC/Vinyl Antistatic	PVC/Vinyl Conductive	Forbo Marmolium	Vitrified/ Ceramic Tiles	Marble	Granite
Unifold	✓	✓	✗	✗	✗	✗	✗	✗	✗
LFW	✓	✓	✓ Ebeed	✓ Ebeed	✓ Ebeed	✓ Ebeed	✓ Eband	✓	✓
Unilock	✓	✓	✓ Ebeed	✓ Ebeed	✓ Ebeed	✓ Ebeed	✓	✓	✓
Ultra Thin	✓	✓	✗	✗	✗	✗	✗	✗	✗
Chipboard Encapsulated 25/30	✓	✓	✓ Eband	✓ Eband	✓ Eband	✓ Eband	✓	✓	✓
Chipboard Non-Encapsulated 38	✗	✗	✓ Eband	✓ Eband	✓ Eband	✓ Eband	✓	✓	✓
Chipboard Non-Encapsulated 30	✗	✗	✓ Eband	✓ Eband	✓ Eband	✓ Eband	✓ Eband	✓ Eband	✓ Eband
Calcium Sulphate	✗	✗	✓ Eband	✓ Eband	✓ Eband	✓ Eband	✓ Eband	✓ Eband	✓ Eband

Edge Beeding: Ebeed

Edge Band: Eband

Integral Trim: IT

Beveled Edge: BE

Unitile Topstone

Your Rock Solid Option

Unitile's Raised Access Floor System is carefully fitted with Unitile's Topstone Floor Panels, which are designed to withstand extreme weight and pressure.

Unitile's Topstone access floor panels (600x600mm) comprise of customer selected Vitrified or any Natural Stones tiles which are factory bonded to the steel cementitious access floor panel with propriety admixed glue to ensure perfect bonding of two different substrate.

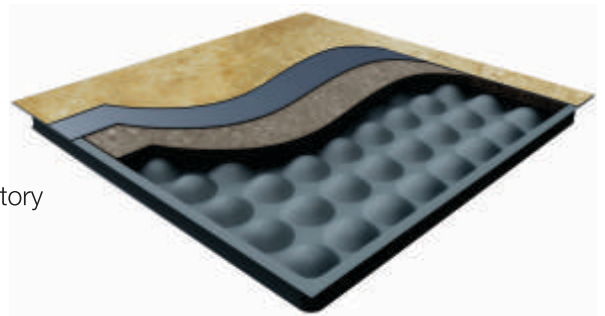

DESIGN FEATURES

◆ **Angular Edge Beeding protection:**

Uniquely engineered to specialize in protection against high heat when replacing topstone panels after usage.

◆ **Cross Section:**

Designed for extreme weight management, holding and equalizing the weight load to ensure stability and durability of each panel.

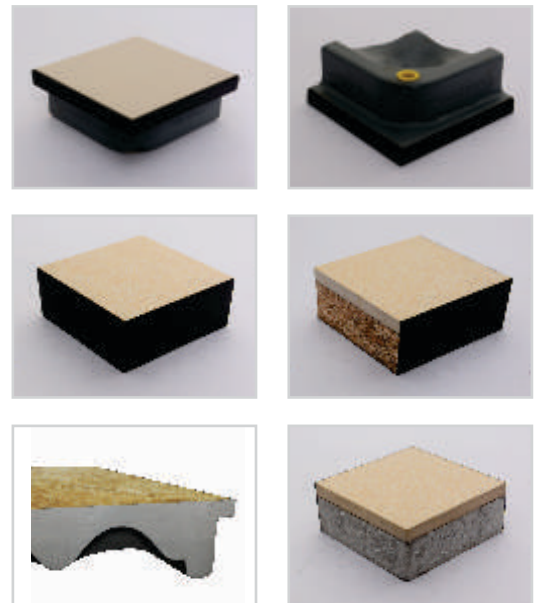

BENEFITS

- ◆ Ease of house-keeping & maintenance
- ◆ Thermal protection
- ◆ Resistance to water stains & absorption
- ◆ Chemical Resistance
- ◆ Anti - Skid
- ◆ Non inflammable
- ◆ Aesthetics appeal

System Selection Guide

Grade	Concentrated Load Kgs (lbf)	Ultimate Concentrated Load Kgs (lbf)	Uniform Distributed Load Kgs/Sqmt (lbf/sqft)	Rolling Load* kgs (lbf)
Unitile Topstone	680 (1500)	1700 (3748)	2040 (419)	315 (694)

* Contact us for detailed specifications of the product design.

Understructure Support System: Gravity Lay

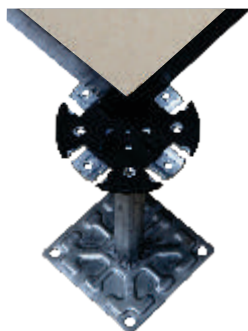

Identical performance features as the Unitile Corner Lock System, used for finished floor height as low as 65mm. With this systems the range of vertical adjustment is therefore limited.

Understructure Support System: ESGR

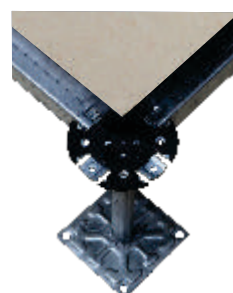

Edge support under-structure provides maximum floor stability. It reduces all lateral movements and also ensures integrity of the floor on removal of panels for access to services in the sub-floor. Stringers are mechanically fastened to the pedestal head and panels are then placed on the grid formed. This system is ideal for high finished floor heights.

Unitile All-Weather Pedestal

Raised Access Flooring Systems for evolving external spaces.

The Unitile All Weather Pedestal has been designed and engineered for use in conjunction with *outdoor tiles (Natural Stone/Ceramic/Marbles/Concrete Paver Blocks/Vitrified tiles) to create raised floors on external spaces. The pedestals create a void between the concrete slab and the outdoor tiles that accommodates and conceals services and also offers easy and cost-effective access for maintenance when required. The open gaps between the outdoor tiles allow the water to drain off into the cavity created under the panels. This solution allows for any underlying elements to be inspected and offers a practical passage for pipes.

Unitile All Weather Pedestal is geared towards giving the specifier not just a product that meets and exceeds the required specification, but technical and on-site support that ensures the installation proceeds on spec, on time and on budget.



BENEFITS

- ◆ Height range Fully adjustable system from 17 to 850mm.
- ◆ High loading supports loads in excess of 1000 kg per pedestal.
- ◆ Easy access services running in cavity below can be easily accessed.
- ◆ Slope adjustment patented slope corrector can create or compensate for up to 5% pitch.
- ◆ Water control system allows for simple, fast removal of rainwater via access cavity.
- ◆ Sustainable pedestals manufactured from 78% recycled PPC and are 100% recyclable.
- ◆ Design versatility.
- ◆ Configurable Pedestal spacing options allow for all complex layouts, abutments, penetrations and edge details. All positions are lockable by special patented key.
- ◆ Allows for positive drainage & air ventilation.
- ◆ Reduces sound transmission & increases temperature insulation.
- ◆ Ability to conceal services (i.e. plumbing, electrical etc).
- ◆ Quick & easy installation.
- ◆ Reduces weigh loading by eliminating sand & cement mortar beds.

FEATURES

- ◆ Made from 5mm thick 80% recycled polypropylene
- ◆ 2, 3, 4.5, 6, 8 & 10mm Paver Spacer Tabs
- ◆ Adjustable heights from 17mm to 1070mm
- ◆ UV stable & chemical resistant
- ◆ Provision for mechanical fixing if required
- ◆ Inbuilt safety locking mechanism
- ◆ Millimetric adjustment



Multilayer Underfloor Cable Tray Support System

Conventional Cable Tray systems are grouted on the floor which requires drilling of the slabs resulting in dust generation and poses more risk to high tension slabs. The cables can come in contact with floor water/dampness risking the safety of cables and rusting of the brackets and cable trays. The pedestals can foul with the cable tray which leads to floor instability and unorganized cable routing system. The overall system is rigid and has challenges with the stability of the floor.

Multilayer Underfloor Cable Tray Support System is an engineered under grid cable tray support system made with heavy grade slotted angles along with special head for snap on easy installation.

The grid is available in different finishes like hot dipped galvanized and powder coated.

DESIGN FEATURES

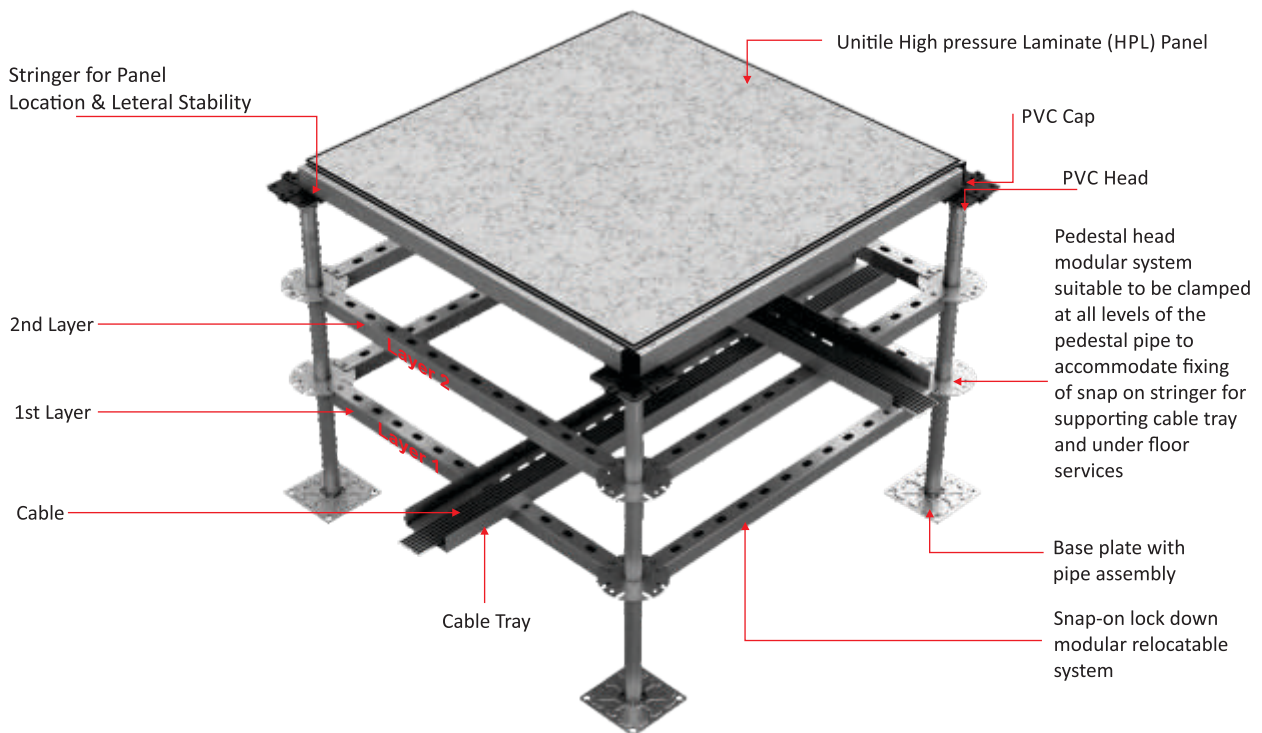

BENEFITS

FULLY MODULAR SYSTEM:

Special head for snap on easy installation and heavy grade slotted angles enable:-

- ◆ Last minute changes since this grid is flexible and can be installed wherever as per the site requirement.
- ◆ Accommodation of multiple tiers of cable trays as per site requirement.
- ◆ Onsite adjustable cable tray heights for the user to make changes at site when other services need to run below the floor for example water and gas lines if any.

INTEGRATION WITH THE RAISED FLOOR SYSTEM IMPROVES SPEED OF INSTALLATION:

- ◆ Since this system is completely modular, if the Raised Access Floor installation is done along with the Under floor Cable Tray System then the entire system will require minimum alignments procedures. This is because the placement of the grid is fixed hence a default installation of 600mm center to center (c/c) placement is achieved.
- ◆ The cable tray support system is also ready along with it, hence this reduces the coordination time and sequence of working with the electrical contractor (which they generally do pre installation of raised floor and then open floor panels to install the cable trays).

HIGHER STABILITY & LATERAL SUPPORT:

A seismic compliant raised floor system requires one tier of cable grid throughout the false floor area:-

- ◆ Since this system is interconnected with all the pedestals, the entire false floor will behave as a single grid enabling seismic support.
- ◆ This system indirectly maintains the accuracy of the raised floor grid ensuring the panel fitment & alignment remains intact at all times. It ensures a proper hold of the center to center distances between the pedestals.
- ◆ Without any compromise on the rigidity, the new system design allows the pedestal base to be glued on the subfloor instead of conventional method of anchoring using fastener. This avoids the drilling process and generation of dust in your facility.

ELEVATED CABLE TRAY FEATURE:

- ◆ Prevents the contact of the cables and trays with floor water / dampness.
- ◆ Prevents fouling of cable tray with pedestal.
- ◆ Supports the contractor for doing a neat and clean installation as the path for cable trays are predefined.

Nex-Gen Raised Access Floor System

Unitile has re-engineered the conventional raised floor system design to overcome the challenges faced in the Data Centers and Control Room environments.

Our all new Nex-Gen access floor system has been designed to provide a wider span for cable management during the construction and ease of maintenance post-handover of your facility!

DESIGN FEATURES

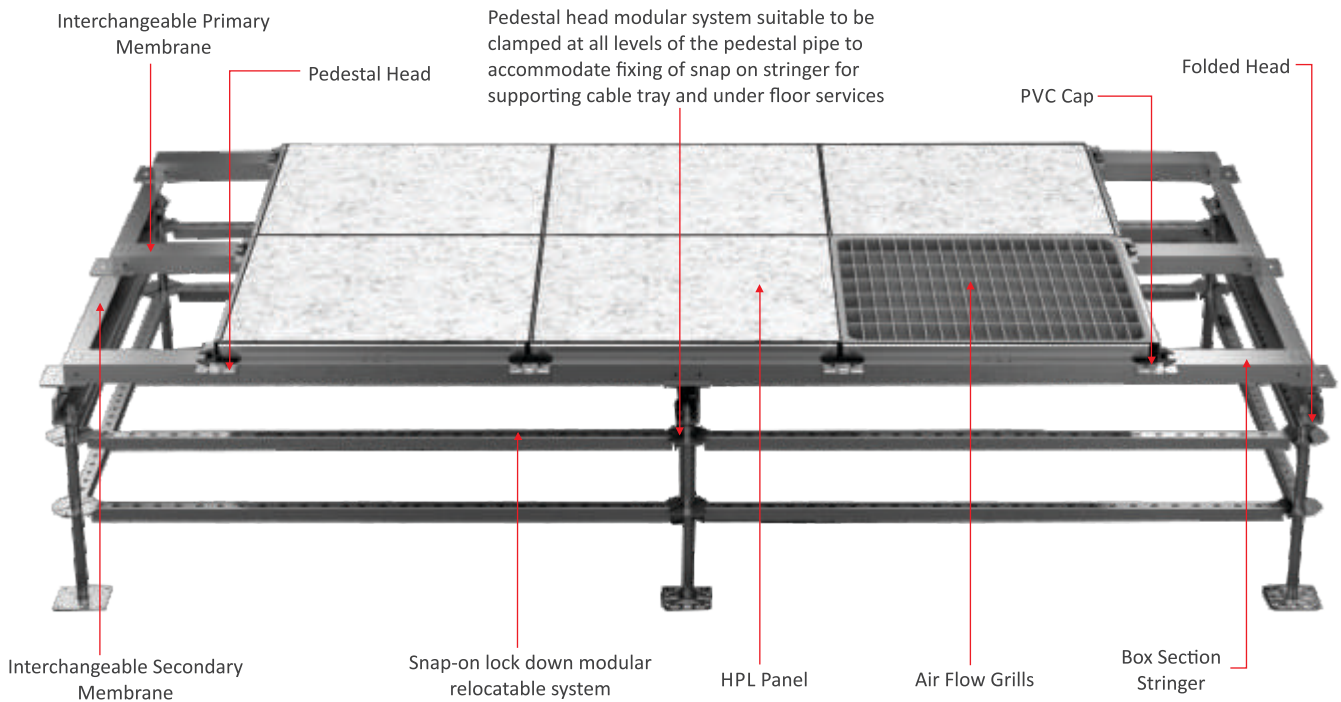

BENEFITS

- 01** A 1200 mm wide plenum space below the floor enables convenience of cable routing.
- 02** Lesser obstruction to larger services running below the floor (above 500 mm).
- 03** The wider span prevents fouling of cable tray systems with the pedestals.
- 04** Ease of maintenance during construction program.
- 05** Ease of maintenance post-handover for the life cycle of your facility.
- 06** Lesser number of pedestals required.
- 07** Faster installations at site due to lesser pedestal.

Ramp Shoe in Raised Access Floor System

The new Unitile Ramp Shoe is designed to provide a smooth transition between the raised access floor tiles and the concrete floor. The system is generally used in applications, which require heavy footfall movement & rolling of equipments into the facility using trolleys. Example of such spaces includes commercial offices & data center facilities.

The product is made up of heavy-duty anodized aluminum. The Ramp Shoe features a trapezoid anchoring leg, which is firmly secured to the concrete floor. The system is securely fastened to the concrete floor at regular intervals with the use of fasteners. The ramp provides a sloped transition surface that terminates at the height of the access floor tile edge. The profile protects tile edges to eliminate trip hazards and ensures easy access of trolleys.

The Ramp Shoe is a full 15 inches wide which meets ADA 1:12 requirements for ramped surfaces. It protects the ramp from equipment damage and makes an excellent seamless transition between two surfaces.

The Ramp Shoe are available in following sizes:

- ◆ 2000 mm L X 165 mm B X 50 mm H
- ◆ 2000 mm L X 395 mm B X 50 mm H with option for provision of dust matting strips.

**Lengths above 2000 mm are also available upon request.*

DESIGN FEATURES

Model 1:- Standard Ramp Shoe

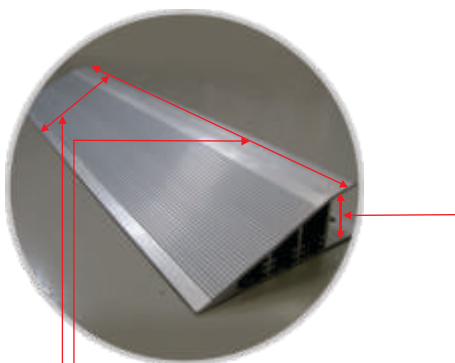

Length – 2000mm
Breadth - 165mm
Height - 50mm

Model 2:- Unitile Dust Control Ramp Shoe

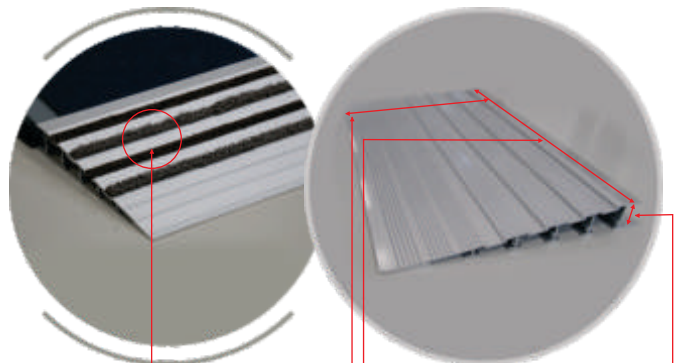

Dust Matting Strip

Length – 2000mm
Breadth - 395mm
Height - 50mm

BENEFITS

01 Provides smooth transition between the raised access floor tiles and the concrete floor.

02 Takes care of rolling of heavy equipment such as trolleys & heavy footfall.

03 Unitile dust control Ramp Shoe are designed to:

- ◆ Remove dirt and moisture from shoes
- ◆ Prevent debris from entering the building
- ◆ Keep entrance ways looking clean and presentable
- ◆ Reduce slips, trips and falls from slip hazards on wet floors.

Bridge in Raised Access Floor System

Bridge is a component used in raised floor whenever the pedestals are fouling with cable trays or any other underfloor services. It prevents breaking the continuity of the raised access floor due to the intersection between the pedestal and other underfloor services.

The heavy duty bridge is made up of powder coated 'C' channel of size 90 mm X 35 mm thickness with designated pre punched tapping locations to secure the pedestal head and PVC cap. The pre punched tapping locations corner locks the panels for maintaining the panel alignment and for balancing the panel.

It is available in length of 1200 mm and 1800 mm.

**Wider dimension can be made available on request.*

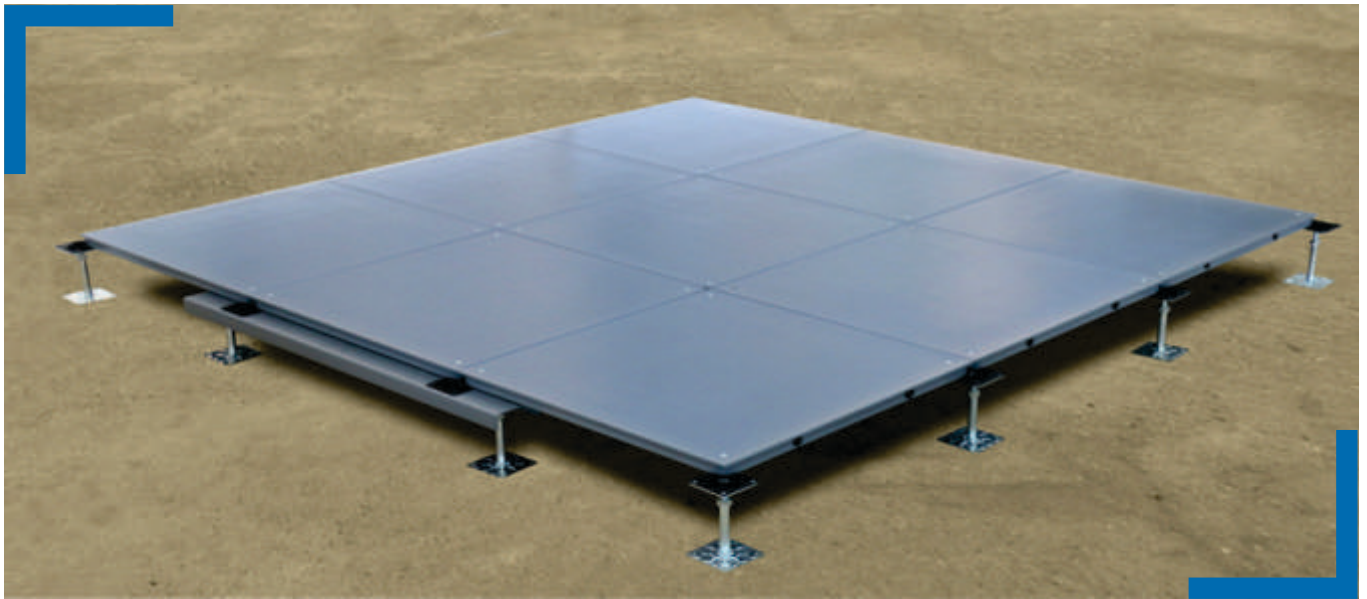

ADVANTAGES

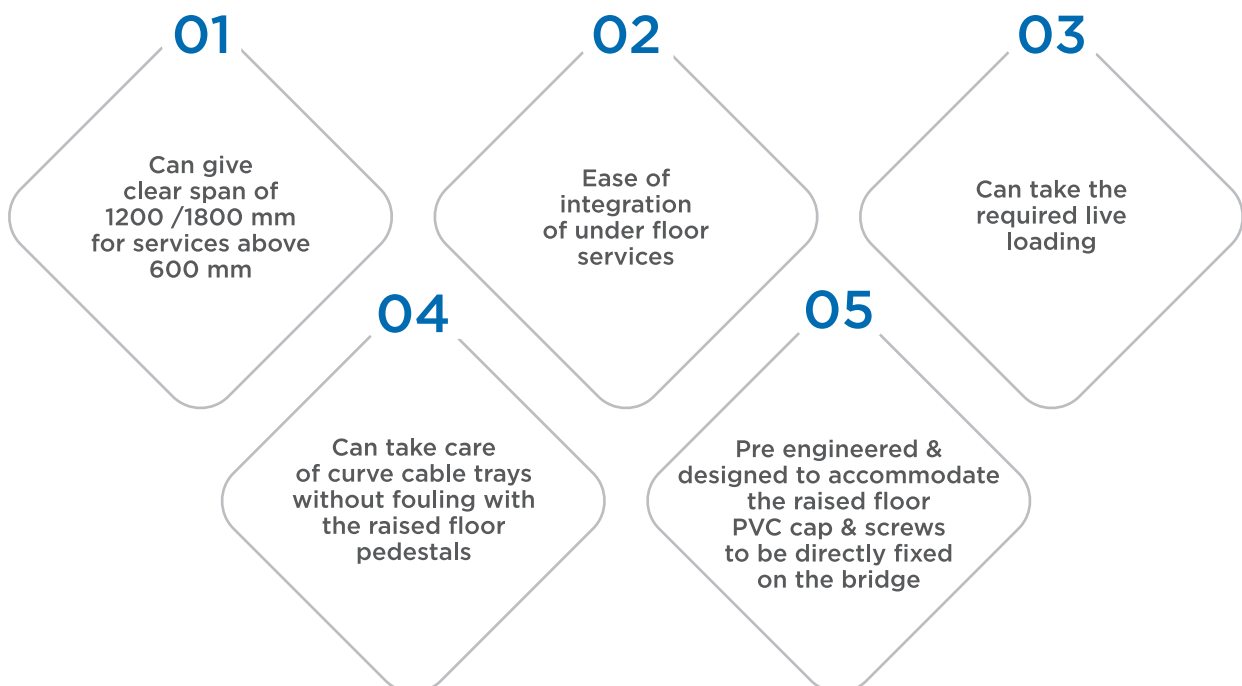

Data Center Solutions

Rapid evolution of the data center is creating boundless new opportunities, but along with those come urgent monitoring and management challenges. Energy consumption is one of the growing concerns for data centers.

Advances in server equipment technologies and increased demand for computing power have increased load densities in the computer room, which in turn has caused corresponding increases in data center power consumption. Energy efficiency measures are thus of high importance for data center designers, operators, and owners.



Unitile has developed a range of cost-effective and energy efficient solutions that provide data center owners with compelling returns on investments and lower operating costs in both new build and retrofit applications. Key features of the concept include:

01

- ◆ Reduces air loss in under floor cooling systems.
- ◆ Enhances the performance of cooling equipment.

02

- ◆ Enhances overall energy efficiency of the Data Center.
- ◆ Unmatched ability to handle high density server racks of the most mission critical facilities.

03

- ◆ Enables uniform balancing of air throughout the critical space
- ◆ Ensures proper air distribution at various rack levels

U-FLEX offers your data center best-in-class solutions to efficiently manage maintain a healthy, secure, and cost-efficient data center.

Data Center Accessories

U-FLEX AIR PLUGS Air Control Solutions

Data Center servers generate high heat output and hence keeping them cool and operating it efficiently is very important. Data centers that are not well managed often suffer from hot spots leading to equipment failure. These servers are often fitted into smaller footprints that require higher cooling capacity. Additional cooling capacity demands more cooling units, which is expensive. A better solution is to plug the loss of cold airflow before adding more cooling capacity and ensures its direction to where it is needed the most.

Air Plugs offer a series of engineered raised-floor grommets to plug cut-outs within the raised-floor and stop cold air from escaping, while still allowing cables to pass through.

Air Plugs raised floor grommets are static dissipative and prevent static discharges being carried up to the cables. Air Plugs thus drastically improves data center environment by plugging cut-outs within the raised-floor.



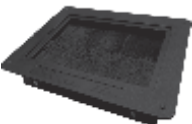

Model No: UFAP-101			
Integrated Raised Floor Grommets		US unit (Inches)	Metric (mm)
	Usable Cable Area	8 x 4	203 x 102
	To Install grommet in interior of the tile	9¼ x 6¾	235 x 172
	To install long side of the grommet on tile edge	9¼ x 7½	235 x 191
	To install short side of the grommet on tile edge	10¼ x 6¾	275 x 172

Model No: UFAP-202			
Surface-Mount Raised Floor Grommets		US unit (Inches)	Metric (mm)
	Maximum Cutout size sealed	10 x 7¼	254 x 184
	Usable Cable Area	8¼ x 4	210 x 102

Model No: UFAP-203			
Large Surface-Mount Raised Floor Grommets		US unit (Inches)	Metric (mm)
	Maximum Cutout size sealed	10 x 9¼	254 x 248
	Usable Cable Area	8¼ x 4	210 x 102

Model No: UFAP-204			
Extra-Large Surface-Mount Raised Floor Grommets		US unit (Inches)	Metric (mm)
	Maximum Cutout size sealed	10 x 13	254 x 330
	Usable Cable Area	8¼ x 4	210 x 102

Model No: UFAP-303			
Split Integrated Raised Floor Grommets		US unit (Inches)	Metric (mm)
	Maximum Cutout size sealed	9¼ x 6¾	235 x 172
	Usable Cable Area	8 x 4	203 x 102

Model No: UFAP-012			
Extended Raised Floor Grommets		US unit (Inches)	Metric (mm)
	Maximum Cutout size sealed	23¼ x 4	600 x 102
	Usable Cable Area	23½ x 2½	590 x 64

Model No: UFAP-013			
Extended Brush Raised Floor Grommets		US unit (Inches)	Metric (mm)
	Maximum Cutout size sealed	24 x 4	610 x 102
	Usable Cable Area	23½ x 2½	600 x 64

Model No: UFAP-G50			
Circular Brush Grommets		US unit (Inches)	Metric (mm)
	Maximum Cutout size sealed	3½ x 0.8	82 x 20
	Usable Cable Area	3 x 0.8	75 x 20

Model No: UFAP-G100			
Split Circular Brush Grommets		US unit (Inches)	Metric (mm)
	Maximum Cutout size sealed	4½ x 2	105 x 50
	Usable Cable Area	4 x 2	95 x 50

U-FLEX AIR PLUGS

Air Control Solutions

DESIGN FEATURES

- ◆ Plugs the openings in the raised floor and prevents cold air from escaping at unwarranted areas.
- ◆ The grommets integrate with the raised floor static dissipation system, providing 1 Giga Ohm of resistance.
- ◆ Allows easy pass-through of power plug connectors and large cable bundles of up to 4" x 8".
- ◆ Constructed with more than 25,000 filaments of resistant & durable flame retardant ABS polycarbonate material.
- ◆ Realize up to 92-100% seal per grommet.
- ◆ Contains no loose or partially fastened parts.

BENEFITS

- ◆ Reduces air loss in under floor cooling systems.
- ◆ Increases under-floor static pressure.
- ◆ Enhances the performance of cooling equipment.
- ◆ Allows flexibility and simplicity in cable routing.
- ◆ Easy installation and cost effective.
- ◆ Reduces the need to purchase additional cooling unites.
- ◆ Improves cool air delivery through perforated tunes and floor grates.
- ◆ Decreases humidity control expense.



Superior Sealing

New, patented Hybrid Brush Technology (HBT) offers exceptional sealing and airflow management, unsurpassed by other leading brush products on the market today.



Easy Installation

Simple, installation saves time and labor and requires no downtime. Round grommets enable hole saw installation which reduces cutting time by over 50%.



Maintenance free

Hybrid Brush Sealing Technology automatically seals around cables with no additional maintenance or monitoring required.



Longevity

Durable ABS frame and Hybrid Brush sealing surface can be used for years.

U-FLEX STANDARD AIRFLOW GRILLS

U-flex Standard Air Flow Grills are manufactured from mild steel with a perforated top having an over all dimension of 600 mm x 600 mm. The panels consist of a specially designed side channel section which houses a pre-punched top perforated sheet and is available with optional volume control damper (VCD). The central core of the panel is fitted with a grid of vertical steel blades to avoid airflow turbulence and to minimize pressure drop.

A vertical mesh is provided to support the airflow grill at regular intervals to ensure flatness and high load carrying capacity. The panel can be compatible with the adjacent raised access floor system. The top performance finishes is powder coated and can be available with high pressure laminate finish as per the users requirement.

27% Opening

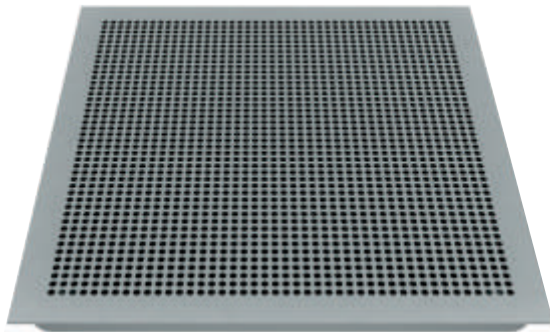

46% Opening

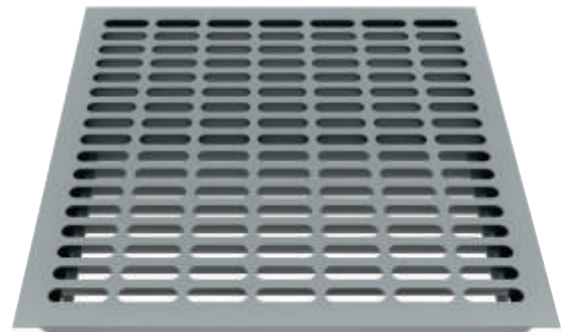

Technical Specification

Standard Air Flow Grills	Size of the Active Grill	Min. Permissible false floor height	CFM	Concentrated Load	Uniformly Distributed load	Air Flow Direction
27%	600 x 600 mm	450 mm	350 - 500	540 kgs	1620 kgs/Sq.mt.	STD
46%	600 x 600 mm	450 mm	350 - 500	540 kgs	1620 kgs/Sq.mt.	STD

* Contact us for detailed specifications of the product design.

DESIGN FEATURES

01 High load carrying capacity.

02 Cost effective solution.

03 Equal airflow performance in both finishes- powder coated & laminated.

04 Enables uniform balancing of air throughout the critical space.

05 Available with height adjustment feature to complement the adjacent raised access floor system.

06 Available with an option of adjustable dampers to manage airflow volume.

U-FLEX DIRECTIONAL AIRFLOW GRILLS

In today's rapidly changing technology in data centers it is important to ensure that every component of support infrastructure is operating with maximum efficiency and reliability. The continued adoption of high-density racks and cloud computing strategies require the cooling infrastructure to accommodate to high end changing loads.

Understanding the challenge of cooling the high density server racks, U-flex directional air flow grills provide high energy savings and a cost effective solution for new as well as retrofit data centers. High performance directional airflow grills ensure faster cooling of racks thus leading to high return on investments (ROI) and lower operational costs.

STANDARD | SINGLE DIRECT | DUAL DIRECT

55% Opening



65% Opening

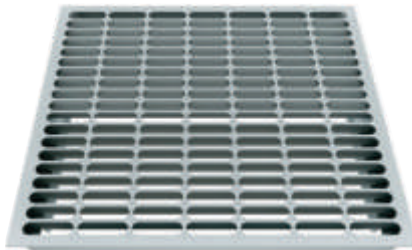

80% Opening



Single Direct Air Flow:

Single Direct Airflow grills are used in a Data Centers where in the cold aisle can accommodate two air flow grills and each grill will direct the air to the adjacent server racks. Single direct delivers cold air directly to the rack ensuring maximum air capture unlike the conventional airflow grills.

Dual Direct Air Flow:

Dual Direct Airflow grills are used in Data Centers where in the cold aisle can accommodate only one air flow grill and the single grill can direct the air to the adjacent server racks. Dual direct delivers cold air directly to the rack ensuring maximum air capture unlike the conventional airflow grills.

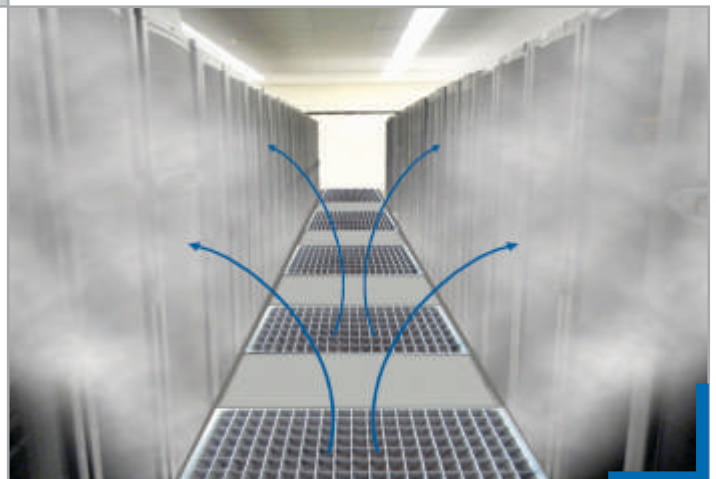

U-FLEX DIRECTIONAL AIRFLOW GRILLS

Technical Specification					
Size of the Active Grill	Min. Permissible false floor height	CFM	Concentrated Load	Uniformly Distributed load	Air Flow Direction
600 x 600 mm	300 mm	700 - 1300	540 kgs	1620 kgs/Sq.mt.	STD/SD/DD

* Contact us for detailed specifications of the product design.

DESIGN FEATURES

- 01** Mild steel construction enhances the load bearing capacities.
- 02** Made from non-combustible material.
- 03** Available with an option of adjustable dampers to manage airflow volume.
- 04** Unique design provides seamless compatibility with all types of raised access flooring system.

BENEFITS

- 01** Achieves close to 94% of air capture
- 02** Enhances overall energy efficiency of the Data Center
- 03** Over 40% annual fan energy savings
- 04** Directional airflow ensures proper air distribution at various rack levels
- 05** Prevents mixing of air & ensures proper air distribution at rack level
- 06** Increases the efficiency of air conditioning equipment in critical spaces
- 07** Unmatched ability to handle high density server racks of the most mission critical facilities

Data Center Accessories

U-FLEX MULTIPLYAIR

U-flex – MultiplyAir cooling system is used in high and medium density data center which always faces unique cooling challenges. There is a considerable increase in the consumption of energy while attempting to cool a few selective racks which often leads to excessive cooling of the other racks. This common phenomenon deteriorates the overall energy efficiency of a data center.

MultiplyAir fan assist module is designed to provide multi-fold cooling through an individual airflow grill that balances and ensures proper airflow to the individual racks. The system is equipped with a unique control feature, which automatically turns on when additional cooling is required. This prevents additional energy consumption caused due to the excessive cooling of server racks.

The MultiplyAir cooling system consists of an energy saving electronically commutated fan which is designed to take care of adaptive load based on the temperature of the server rack. The EC fans are mechanically mounted in the MultiplyAir mild steel construction to ensure smooth function without any vibrations.



The EC fans speed modulation is varied from 0 to 100% depending on the load condition and temperature at the rack level with temperature ranges from 19 Deg C to a maximum of 30 Deg C.

This speed modulation enhances the energy saving of the total system. The inbuilt temperature sensor and controllers monitor this operation. The controller is further equipped with a LCD temperature display interface that can be viewed from the top of the grill.

MultiplyAir is available only with 55% opening.

Technical Specification

Size of the Active Grill	600 x 600 mm
Min. permissible false floor height	450 mm
CFM	1300 or 2500 CFM at 0.1 of H2O (Static Pressure)
Concentrated load	540 kgs
Uniformly distributed load	1620 kgs / sq. mtr.
Air Flow direction	Standard

* Contact us for detailed specifications of the product design.

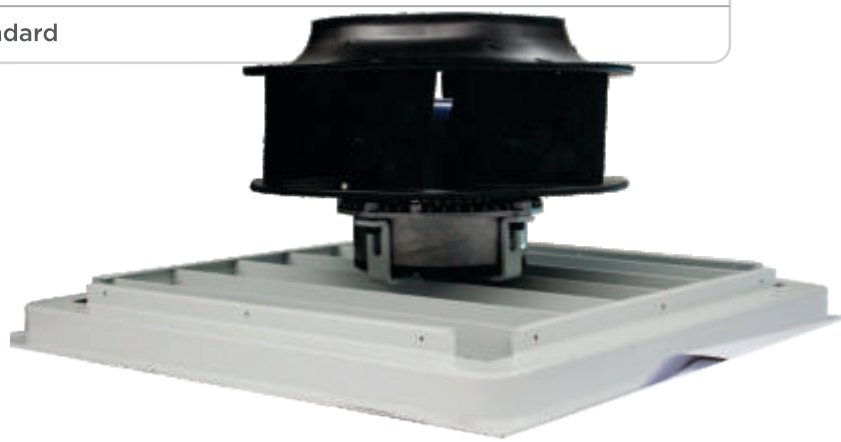

U-FLEX MULTIPLYAIR

MultiYair 1300 used for cooling a server rack of approximately 10 kw

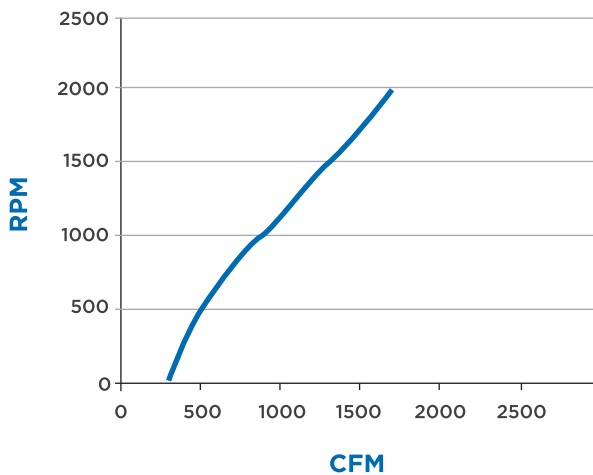

MultiYair 2500 used for cooling a server rack of approximately 15 kw

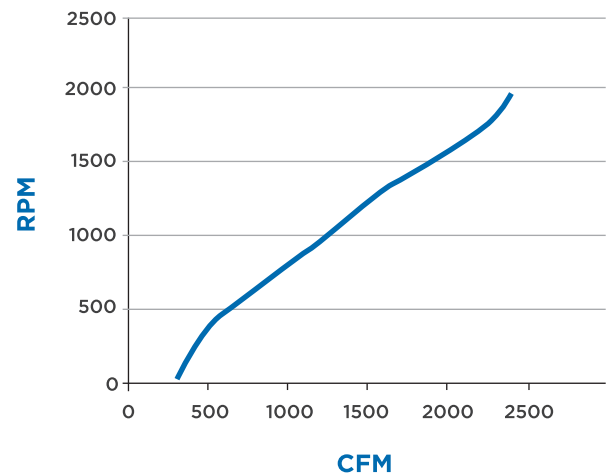

DESIGN FEATURES

- ◆ Available with identical load bearing capacities as the adjacent raised access floor panel.
- ◆ Integrates and reconfigures with existing raised access flooring understructure.
- ◆ The Construction is robust, mild steel.
- ◆ Made up of non combustible material.
- ◆ High quality temperature sensors used for sensing the thermal load variation.

BENEFITS

- ◆ EC backward curve fan ensures low energy consumption.
- ◆ It allows automatic modulation of air flow based on actual thermal load of single rack.
- ◆ Avoids creation of hot spots in critical area.
- ◆ Simple but effective solution for high density racks.
- ◆ Guarantees an intrinsic level of safety, avoids issue of water or refrigerant being near the electronic equipment.
- ◆ It provides high degree of modularity and flexibility without occupying large amount of space in IT room.
- ◆ MultiYair can be easily installed even after the site has been opened if the loads are higher than those which can be met by traditional CRAC solution.
- ◆ Gives a clean, smooth and obstruction free finish to the floor after installation.

OTHER U-FLEX ACCESSORIES



Vision Panel

Vision Panel is constructed with an overall dimension of 600x600mm. The viewing area is made of toughened glass available in sizes of 300x300mm, 450x450mm and 500x500mm. The Vision Panel can be used for viewing critical points that need frequent monitoring and is designed for normal walking load only.



Electroflex

Electroflex is a concealed electrical monument box which has a depth of 70mm to accommodate plug-in facility and 35mm depth to accommodate power, voice and data (PVD) accessories. The hinge lid is constructed with pre-coated galvanized steel and has recessed grey ABS trim to accommodate carpet tiles or any other factory bonded finish to match the adjacent floor finish.



Desk Grommets

Desk grommets are a simple and inexpensive way to keep wires from cluttering your work surface. They are perfect for running your cables through your desk or through a wall. Simply use a hole saw machine to make a hole in the desk / wall, then insert the grommet. Remove the cap so you can insert your cables, then put the cap back in place.



Panel Lifter

Unitile's double cup suction panel lifter(s) allows panels to be lifted quickly, easily and safely without damaging any of the adjoining access floor panels. Not only are they more efficient and safer than using improper tools (screwdrivers, knives), using them will also extend the life of your raised floor. Unitile's panel lifters are designed for use on all access floor panels which includes 'bare' and 'high pressure laminate' panel surfaces.

OUR CLIENTS ARE AT THE HEART OF OUR BUSINESS



OUR CLIENTS ARE AT THE HEART OF OUR BUSINESS





HELP AND ADVICE

+91 99020 10917

For help with flooring materials, costs & specifications, contact Unitile Sales.

OUR PRESENCE

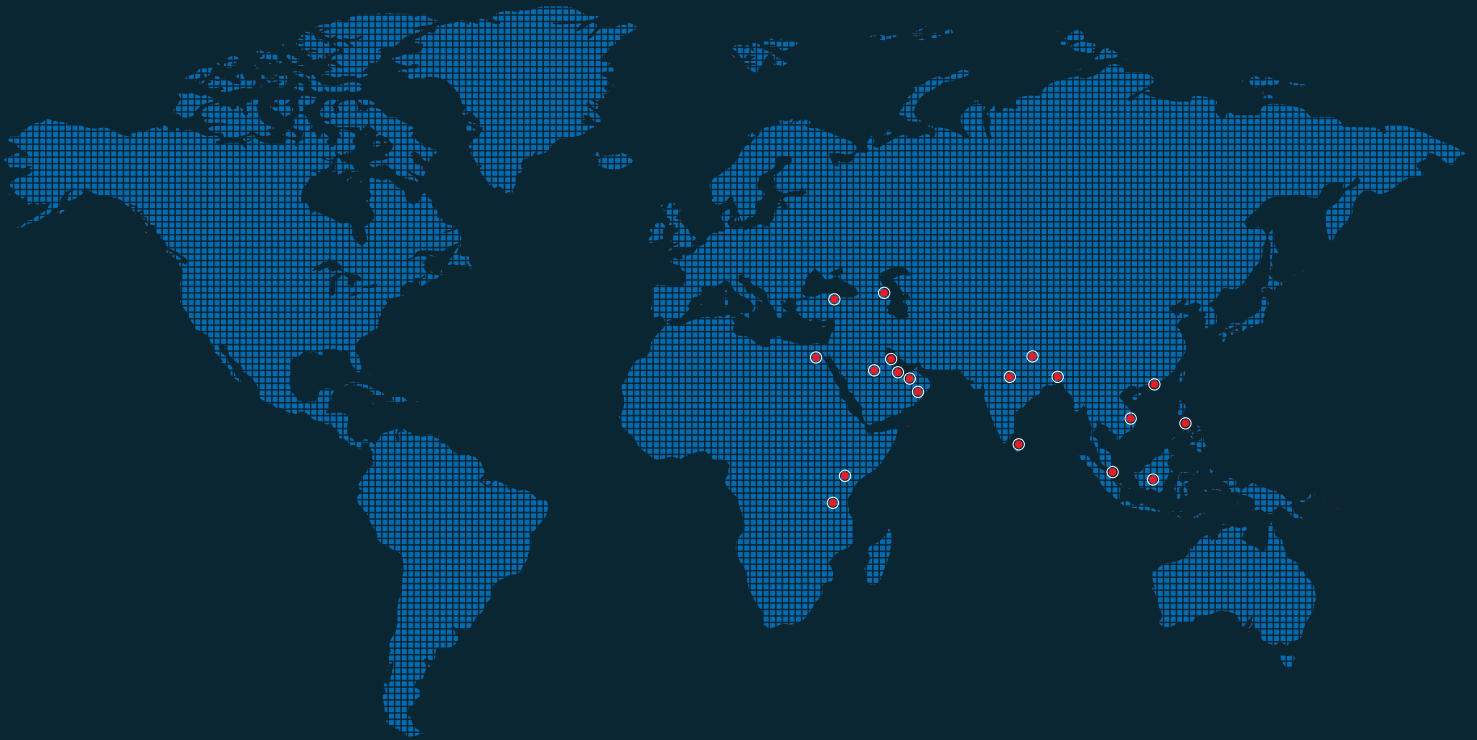

INDIA

Ahmedabad | Ankleshwar | Aurangabad | Bareilly | Bengaluru | Chandigarh | Chennai | Cuttack
Goa | Gurugram | Guwahati | Hyderabad | Indore | Jaipur | Kanpur | Kolkata | Lucknow
Mumbai | Nagpur | New Delhi | Pune | Raipur | Thane | Vadodara

INTERNATIONAL

Azerbaijan | Bahrain | Bangladesh | Egypt | Hong Kong | Indonesia | Kenya | Nepal | Oman
Philippines | Qatar | Saudi Arabia | Singapore | Sri Lanka | Tanzania | Turkey | UAE | Vietnam

📍 **Head Office:** Unit No. 2-G, Laxmi Industrial Estate, New Link Road, Andheri (West), Mumbai - 400053.

☎ 022-2630 5270 / 72

✉ sales@united-group.in

🌐 www.unitileindia.com

